

Wall hung boilers

Synergy 35C

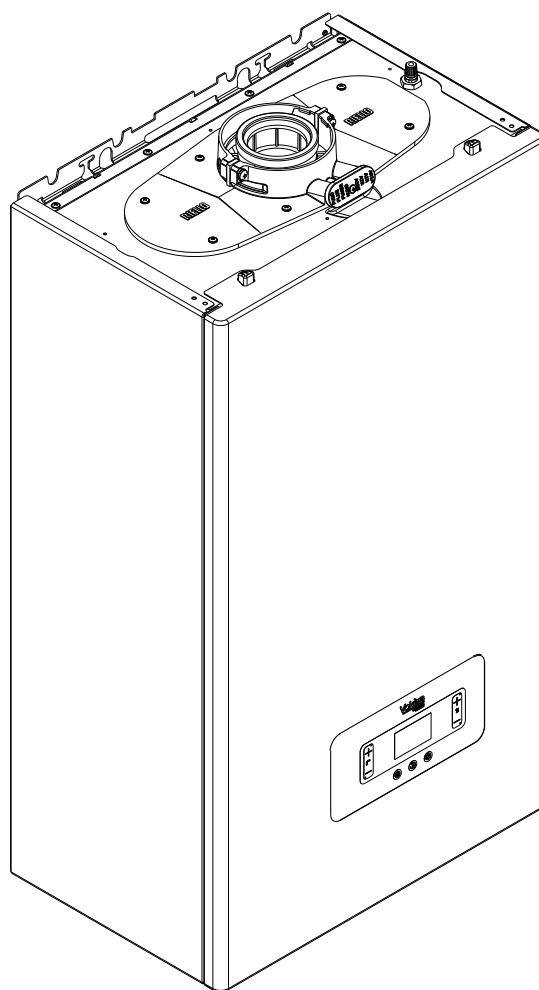

MODEL	PART NUMBER	
	MTN	GPL
Synergy 35C	20207898	

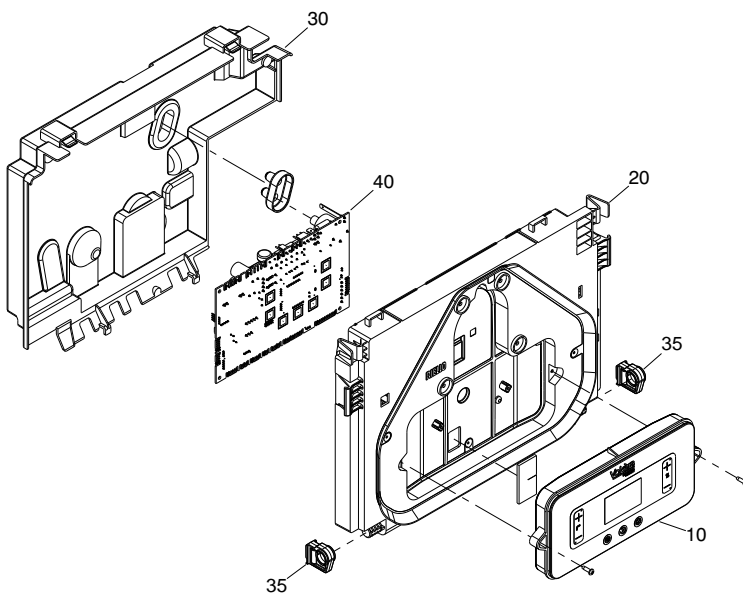
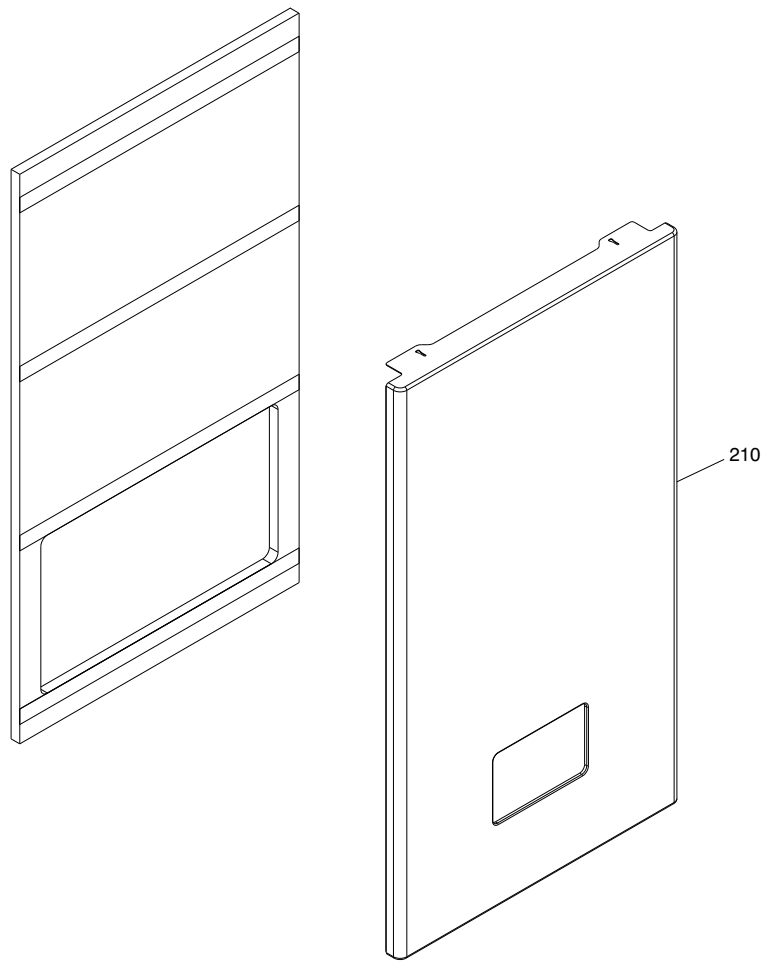

POS.	DESCRIPTION	35C
10	Interface	20210529
20	Cover assembly	20215275
30	Electric parts cover	20206744
35	Control panel hinge	20204261
40	PC board	20216089
210	Case Assembly	20210534

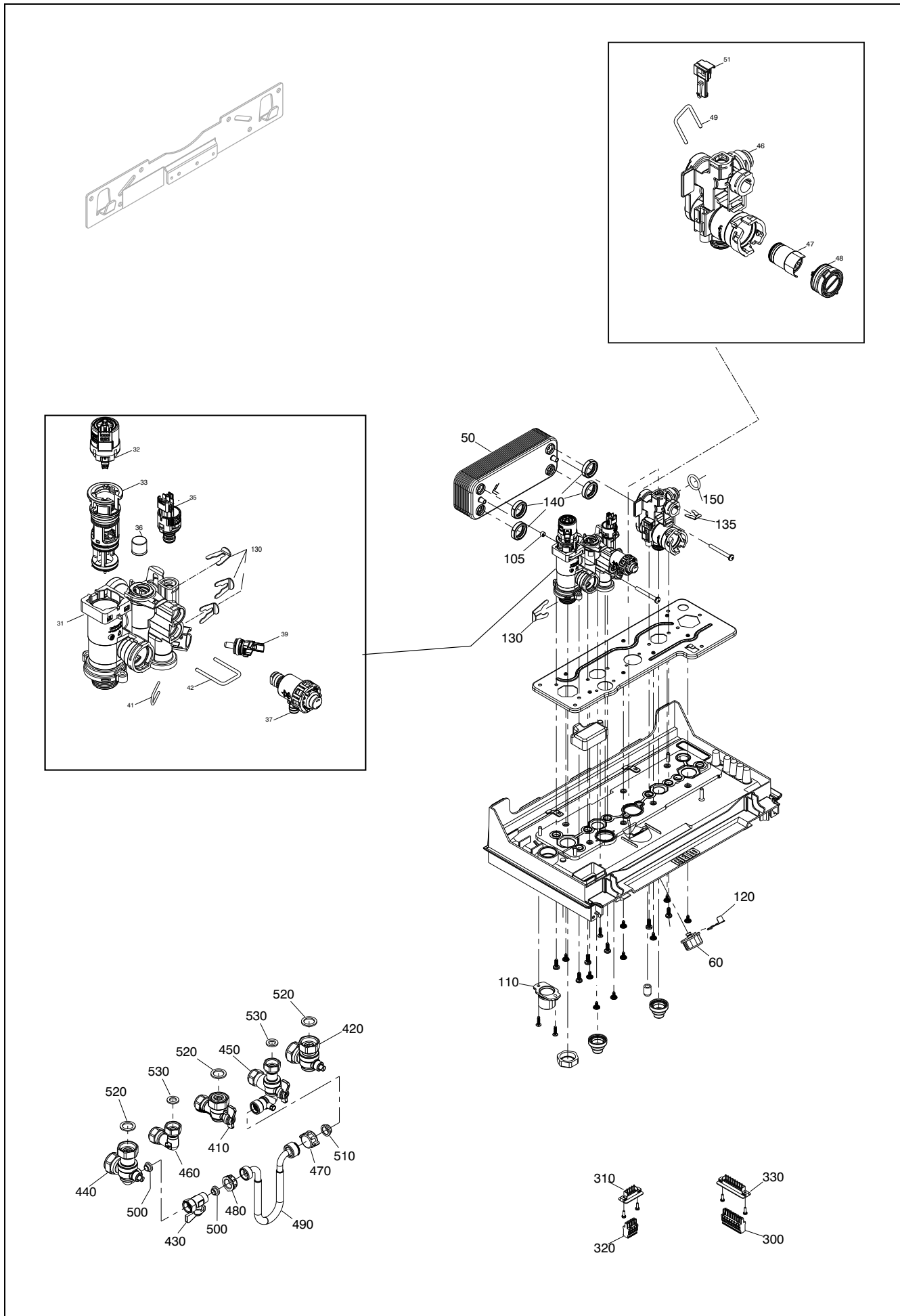

POS.	DESCRIPTION	35C
31	Hydraulic connection	20193766
32	Stepper actuator	20204279
33	Cartridge	20204280
35	Pressure transducer	20188992
36	High head by-pass valve	20196690
37	Safety valve	20204272
39	Temperature detector	20188994
41	Clip	20189052
42	Clip	20189051
46	Modulator	20204278
47	Cartridge	20188607
48	Hole cover	20188600
49	Clip	20188603
50	Exchanger	20208327
51	Printed circuit board	20188605
60	Pressure gauge	20188605
70	Knob	20204275
105	Spacer	20193330
110	Connection	20210527
120	Spring	20204269
130	Clip	20145853
135	Clip	20189064
140	Washer	R10025067
150	Washer	20188460
300	Connector	20154288
310	4-pin connector	20188746
320	4-pin connector	20154287
330	Cable connector	20206745
410	Heating cock	20132650
420	Heat water cock	20132653
430	Filling cock	20132655
440	Cock	20180000
450	Cock	20180001
460	Angle pipe	20132654
470	Cap nut	20133199
480	Cap nut	20133200
490	Pipe	20210528
500	Washer	20133197
510	Washer	20133198
520	Washer	R5023
530	Washer	R5026

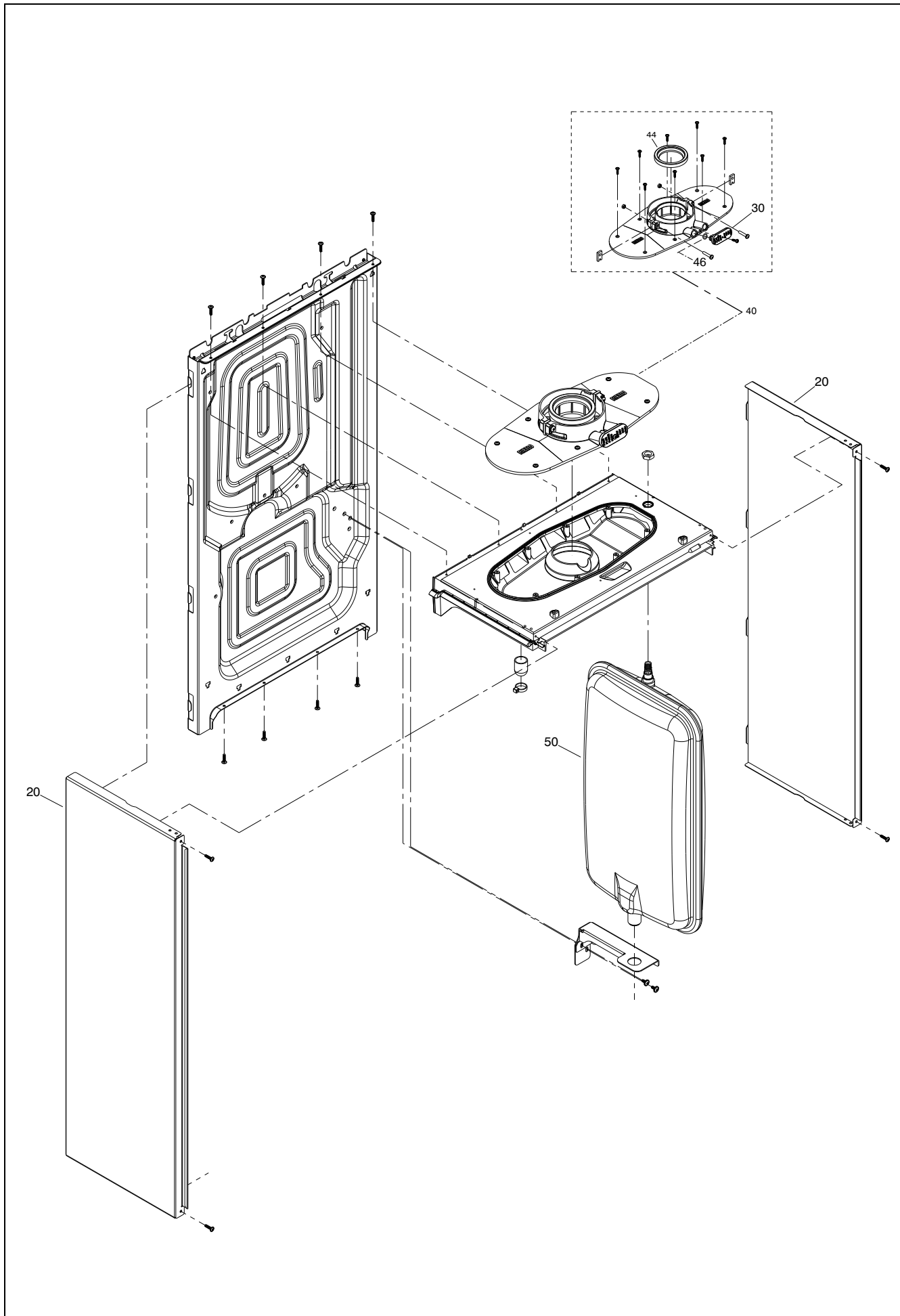

POS.	DESCRIPTION	35C
20	Side panel	20204271
30	Cap smoke analysis	20204849
40	Flange	20204233
44	Gasket fan	20193768
46	O-ring	R10026494
50	Expansion vessel	20204262

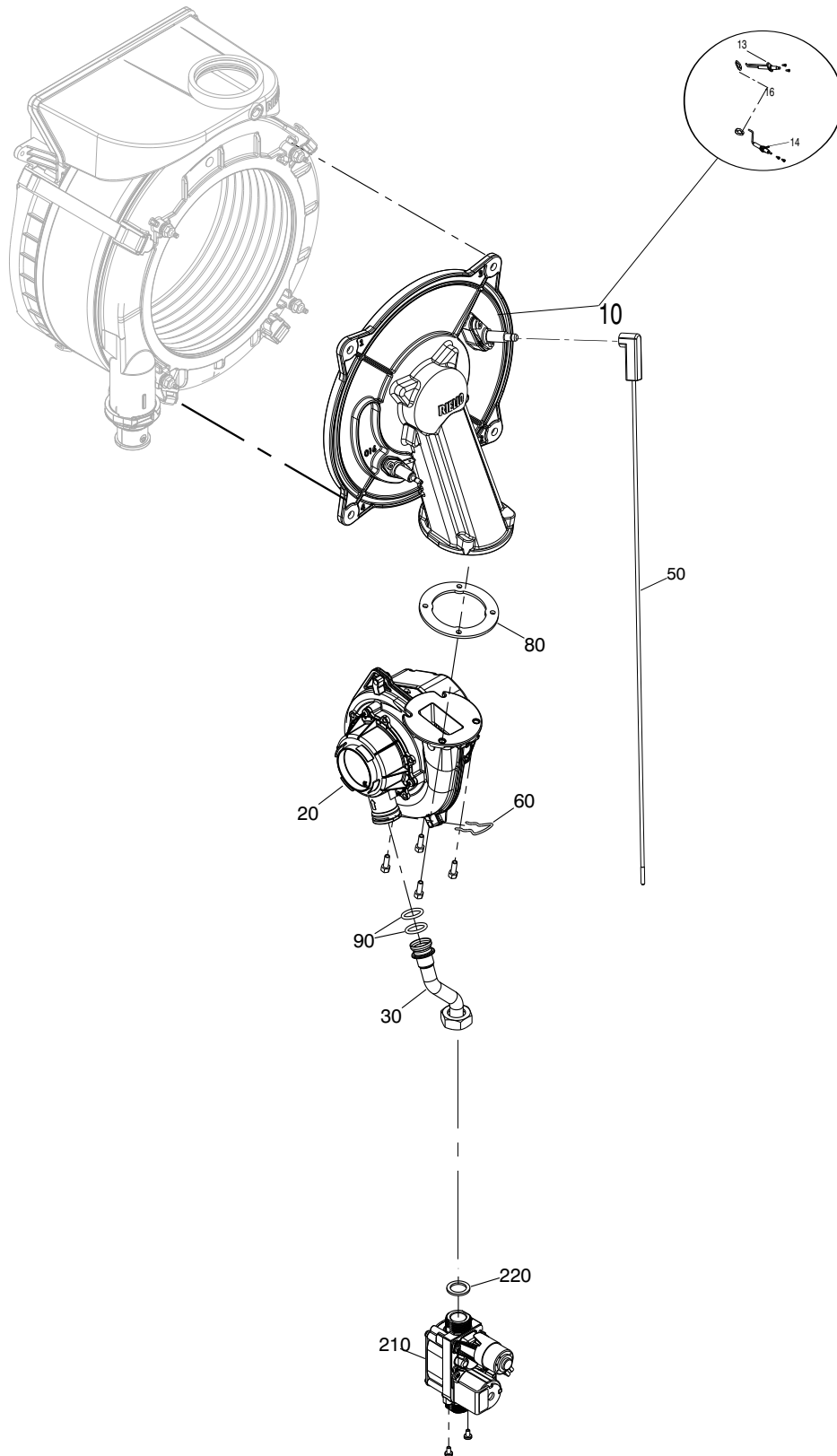

POS.	DESCRIPTION	35C
10	Conveyor	20204267
13	Ignition electrode	20204235
14	Sensing electrode	20135947
16	Electrode seal	20157191
20	Fan	20207761
30	Pipe	20204976
50	Spark electrode cable	20195212
60	Clip	R10025062
80	Washer	R10026796
90	Washer	20204869
210	Gas valve	20204276
220	Washer	R5023

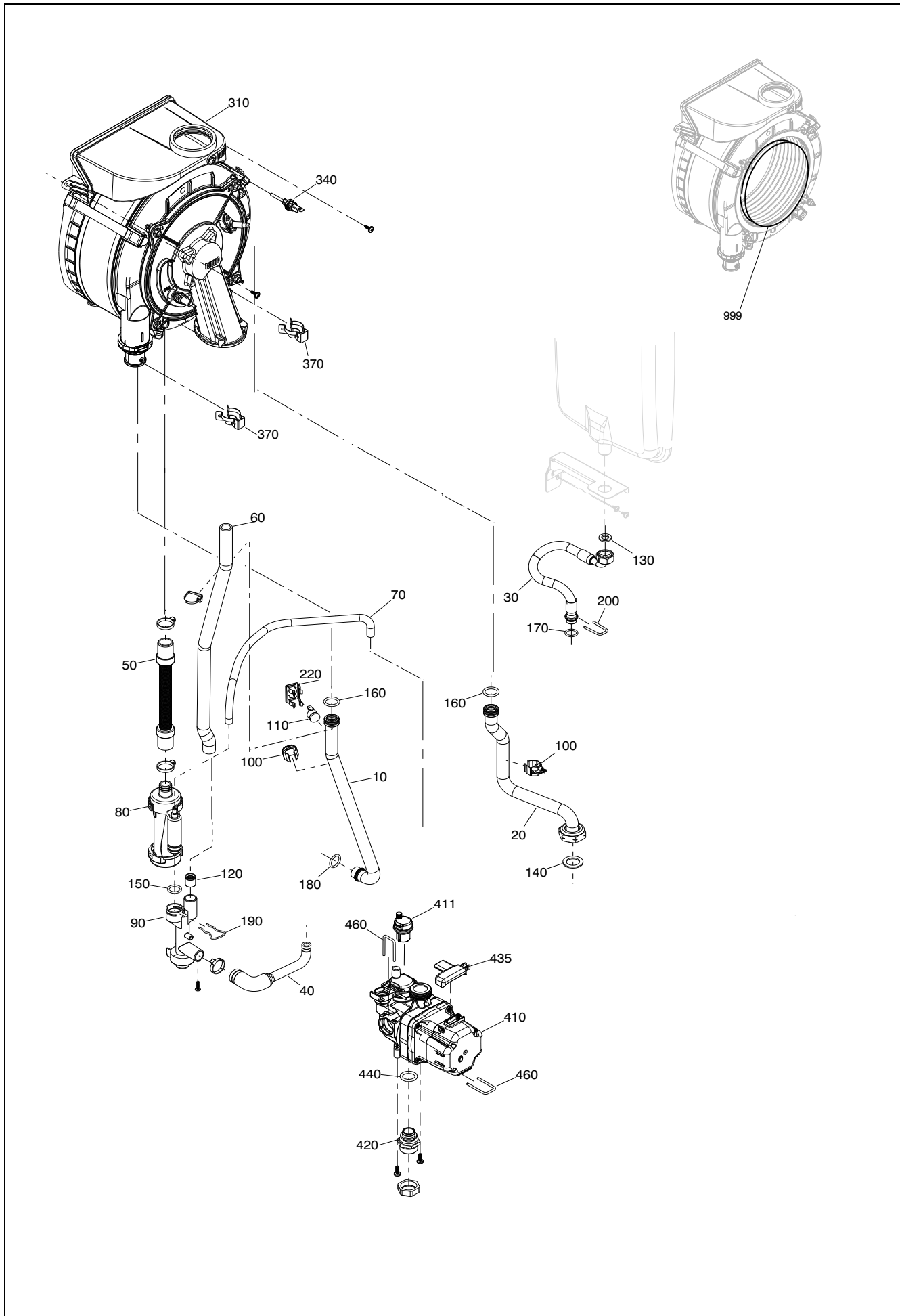

POS.	DESCRIPTION	35C
10	Pipe	20204970
20	Pipe	20204263
30	Pipe	20204268
40	Pipe	20204273
50	Flexible pipe	20000132
60	Condensation outlet tube	20124018
70	Tube kit	20161501
80	Siphon	20188455
90	Condensation outlet (drainage) manifold	20204281
100	Temperature detector	20188488
110	High limit thermostat	20005585
120	Non return valve	20188456
130	Washer	R5026
140	Washer	R9732
150	O-Ring	20140935
160	O ring	20152424
170	O ring	20182412
180	O ring	20000131
190	Clip	R10025062
200	Clip	20188462
220	Clip	R5472
310	Condensing exchanger assembly	20210035
340	Flue sensor	20135782
370	Clip	20204259
410	Pump	20204256
411	Air vent bottle	20169571
420	connector	20188459
435	Support	20204274
440	Washer	20188460
460	Clip	20188603
530	Condensation outlet tube	20100816
999	Retarder insulating panel	20159693

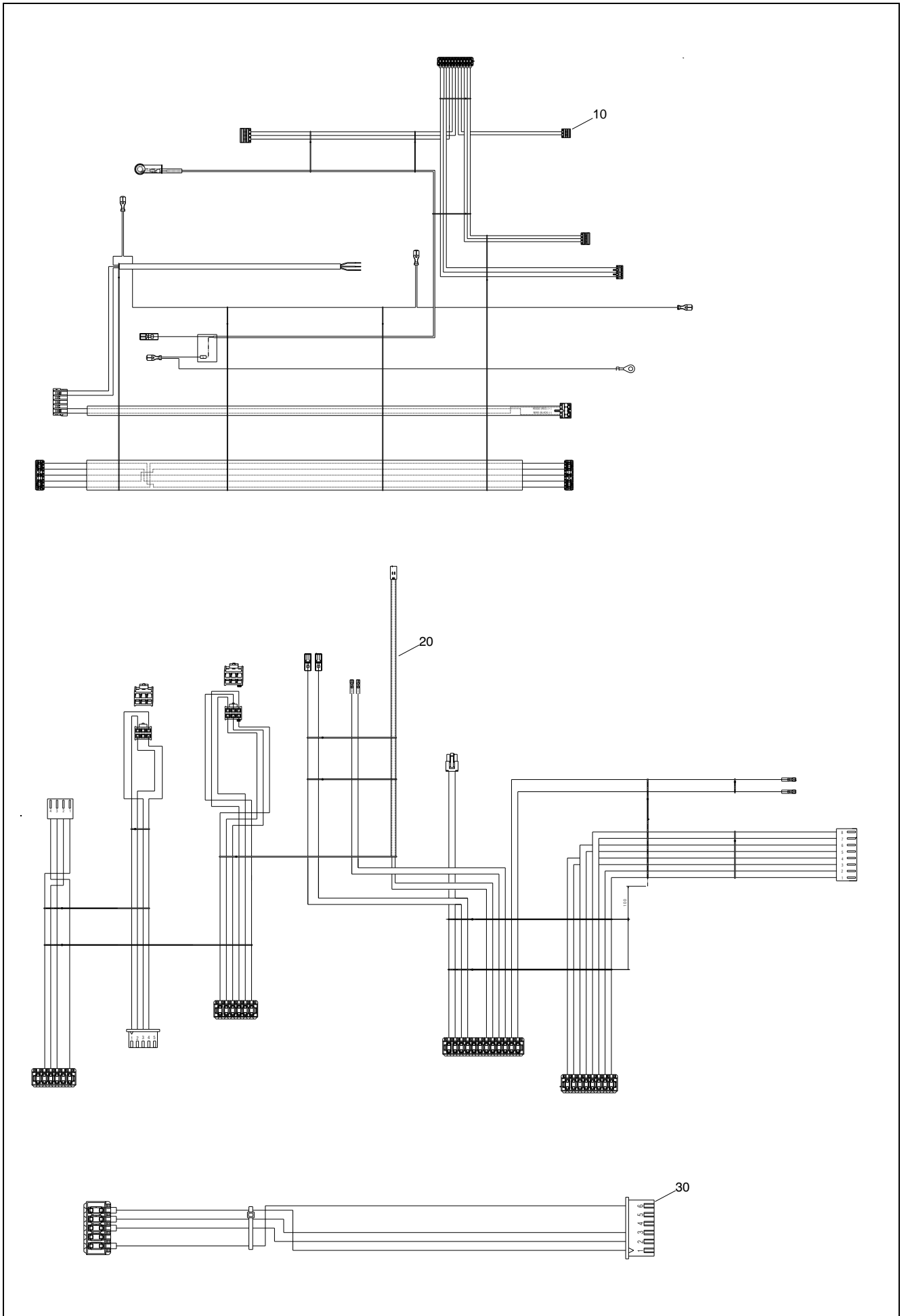

POS.	DESCRIPTION	35C
10	Power wiring harness	20210530
20	Combustion cable	20206751
30	Wiring harness	20206750

Rev	Data	Descrizione



Vokera reserve the right to change the specifications without prior notice.
Consumers' statutory rights are not affected.